

SU3

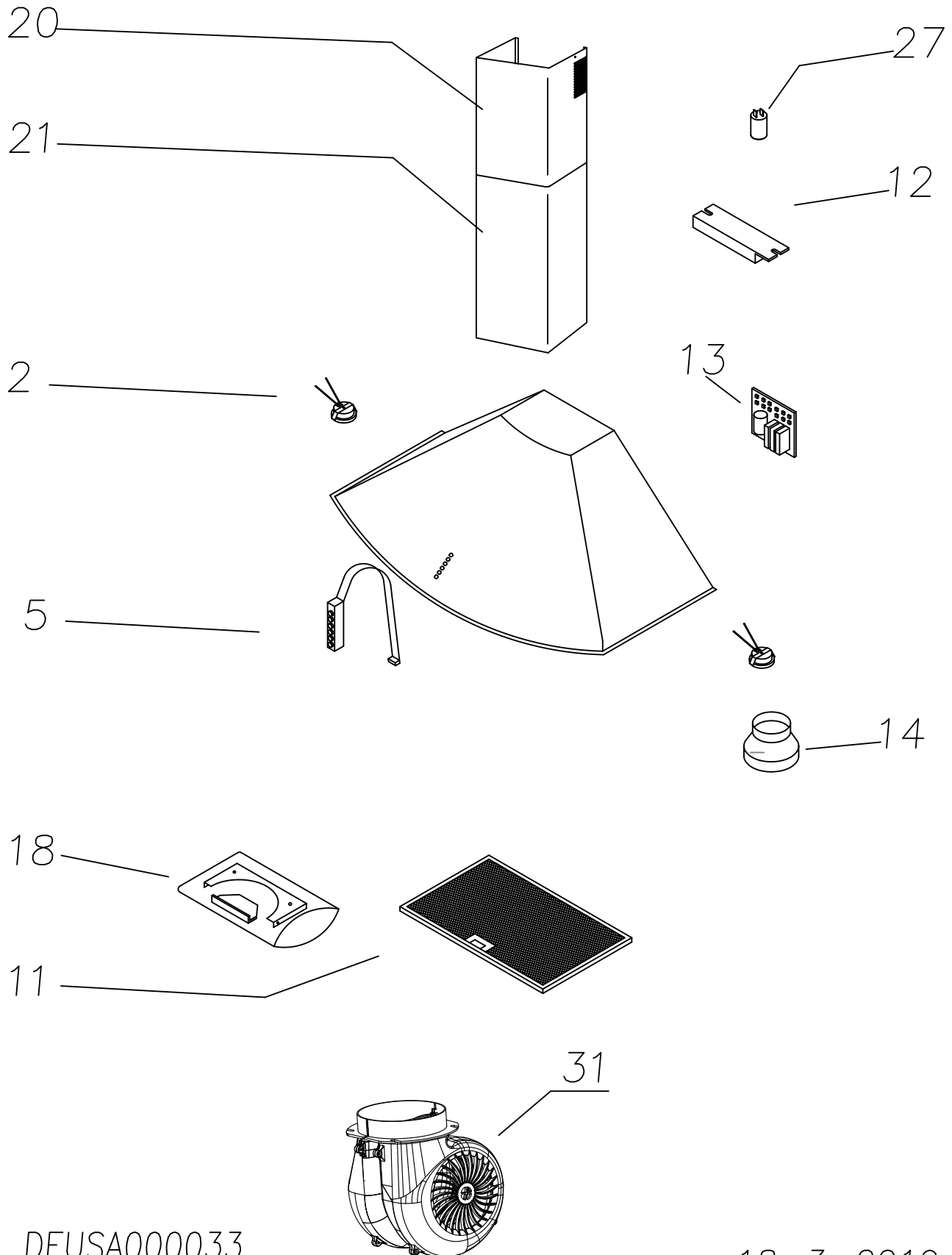

DEUSA000033

18-3-2019